

Hot-Runner Temperature Controller with TC-M01 module

USER'S MANUAL



For avoid wrong operation to make human injured or machine damage, please read this instruction carefully before use the instrument.

WARRANTY

We warrant that this product will be free from defects in materials and workmanship for a period of twelve (12) months from the date of shipment. If any such product proves defective during this warranty period, we, at our option, either will repair the defective product without charge for parts and labor, or will provide a replacement in exchange for the defective product.

This warranty shall not apply to any defect, failure or damage caused by improper use or improper or inadequate maintenance and care. We shall not be obligated to furnish service under this warranty; a) to repair damage resulting from attempts by personnel other than our representatives to repair or service the product; b) to repair damage resulting from improper use or connection to incompatible equipment; or c) to service a product that has been modified or integrated with other products when the effect of such modification or integration increases the time or difficulty of servicing the product.

This warranty excludes replacement of fuses, triac, calibration, contact points and damage to the module from the use of improper styles of fuses. The maximum allowable fuse rating is 15 amps. Lower ratings may be used for improved protection.

SAFETY

Our products have been designed to be safe and simple to operate. As with any electronic equipment, you must observe standard safety procedures to protect both yourself and the equipment.

Cautions:

- Service and installation of this equipment should only be performed by qualified service personnel familiar with high voltage electrical circuits.
- All national and local electrical codes must be followed when connecting

this equipment.

- Only persons with knowledge of the system's operation and capabilities should operate the system.
- Read all of these instructions before connecting power and turning on the system.
- Unless specifically explained in this manual or directed by us, do not attempt to repair the system yourself. Doing so could result in damage to the system, or serious personal injury.

To Prevent Injuries:

- Do not apply voltage to a terminal that exceeds the range specified for that terminal.
- Do not operate this product with covers or panels removed. All unused slots of a main frame must be covered with the appropriately sized blank panels.
- Do not operate this product when wet.
- Do not operate this product in an explosive atmosphere.

To Prevent Product Damage:

- Do not operate this product from a power source that applies more than the voltages specified.
- Do not connect thermocouples to any live areas of the heaters. Lock out and tag the controller and mold and make sure there is electrical insulation between the thermocouple and any live areas.
- After turning on the system, you should make sure that fans are running.
- Never allow the fan outlets on the unit become blocked, This is where the system's cooling airflow exits. If this area of the mainframe becomes cluttered and insufficient airflow or the system maybe damaged.

◆ MAINFRAME

1. GENERAL DESCRIPTION

- This controller is designed as a closed-loop power distribution and temperature controlling system. It provides the user with premier temperature control capabilities.
- This unit has one or more heavy duty connectors (rated 10A or16A) on back, used to connect with the mold by mold-power & thermocouple cables.
- This unit has one or more built-in cooling fans, one or two circuit breakers and power input cable (length is customized). Neon indicators illuminate after power on.



Heavy Duty Connector



Power Input Cable

2. UNPACKING & INSPECTION

- 1) After unpacking, inspect your mainframe and check for any damage that may have occurred during shipment.
- 2) Check the circuit breaker and neon phase voltage indicators for damage.
- 3) Check for proper operation of circuit breaker by flipping breaker on and off with no voltage applied.
- 4) Check power output connector and thermocouple input connector for any physical damage.
- 5) Check AC input power configuration. The power input diagram is located

on the back panel of the mainframe. This diagram indicates the input voltage configuration that was prewired at the factory. Make sure it matches what you ordered.

3. INSTALLATION

- 1) You are installing a piece of electronic equipment which is delicate and should not be subjected to any physical or environmental abuse. Select a cool, dry, well ventilated, environmentally clean location, away from heat, moisture and liquid carrying lines, i.e.: water cooling hoses, hydraulic hoses, etc.
- 2) Unless customized, all controllers will be configured as power supply with single-phase 3-wire 208~240Vac for 1~2 zones controller, and 3-phase 5-wire 380~415Vac for 3~48 zones controller.
Please follow the power supply configuration on the back panel.
If the configuration of power supply needs to be re-wired, please follow the back panel wiring diagram in this manual.
- 3) Route AC input cable to a branch circuit (service) disconnect switch and attach leads to fused side of switch. Be sure ground lead is attached to a good earth ground.
- 4) Connect power & thermocouple cables to mainframe and mold.

WARNING: Before applying power, make sure all national and local electrical codes have been followed and all safety precautions are taken.

IMPORTANT: For mold wiring and heater connection information, refer to mold connector wiring diagram.

4. POWER SUPPLY WIRING

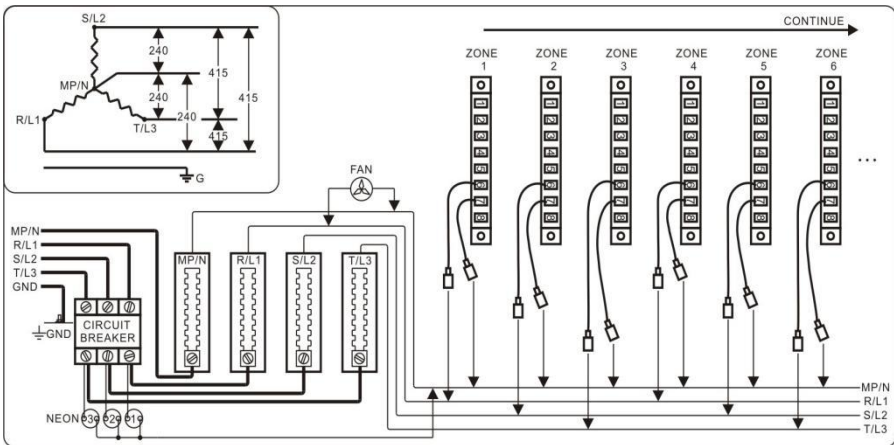

Power Supply Wiring, Diagram A

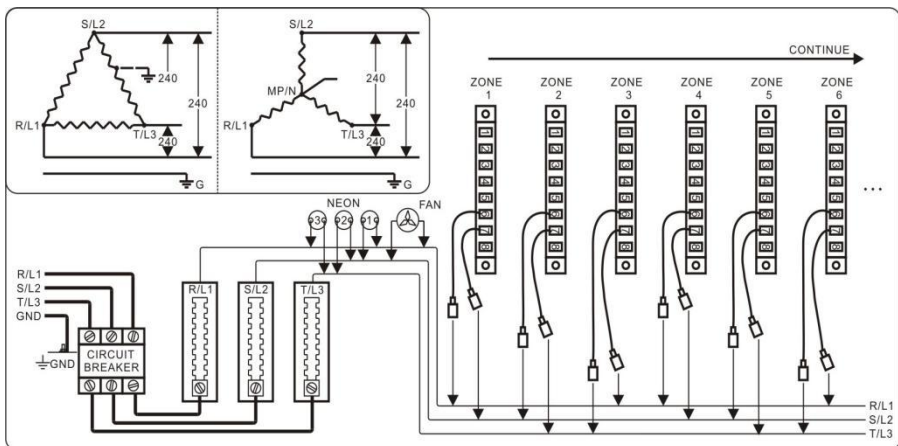

Power Supply Wiring, Diagram B

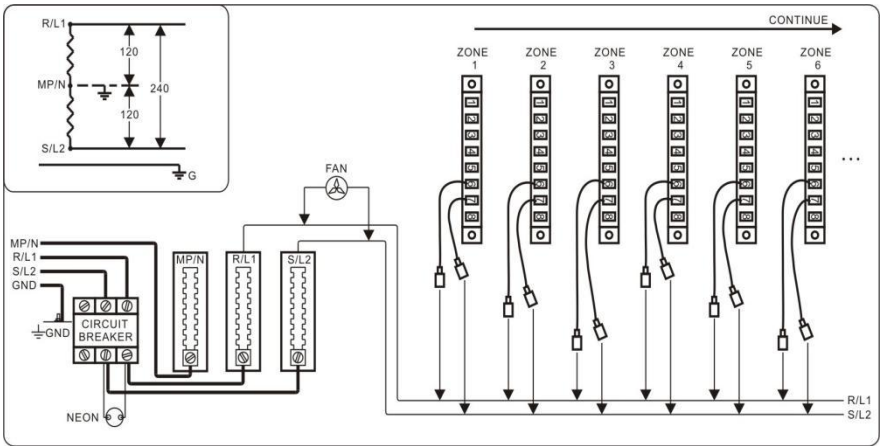

Power Supply Wiring, Diagram C

5. TYPICAL SYSTEM WIRING DIAGRAM

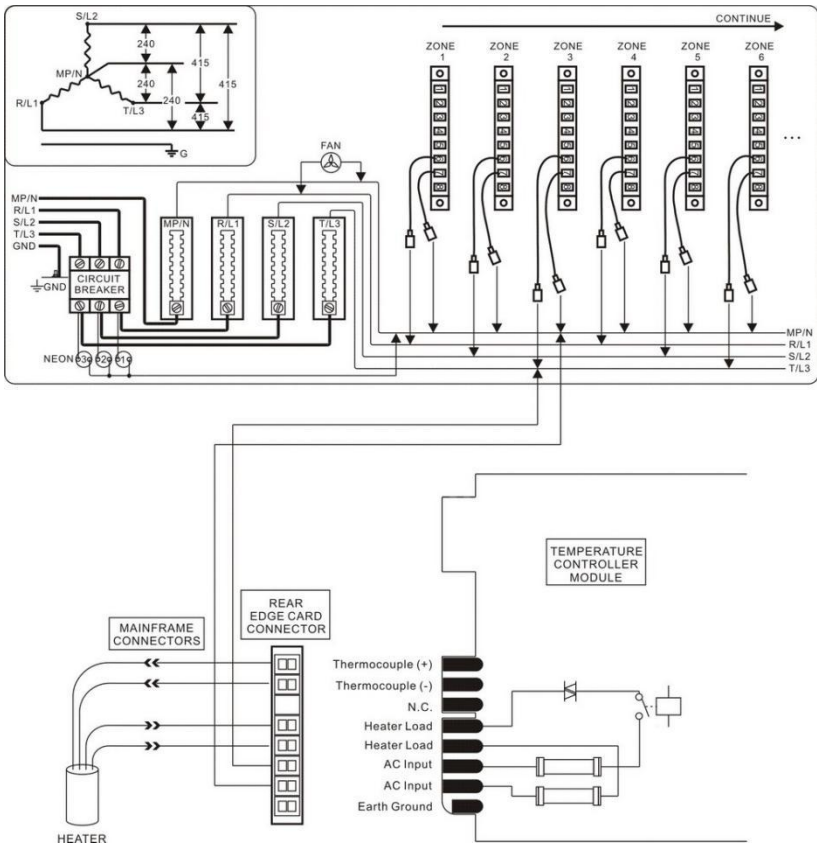

6. TYPICAL HEAVY DUTY CONNECTORS

✓ Insert Type



Male



Female

✓ Insert Specification

HA Series: 4-PIN, 10-PIN, 16-PIN, 32-PIN

HE Series: 6-PIN, 10-PIN, 16-PIN, 24-PIN, 48-PIN

HD Series: 25-PIN

HQ Series: 5-PIN

✓ Housing Type



Single Hook



Dual Hook



Dual Button

✓ **Hoods Type**



Top cable entry with single button



Top cable entry with dual button



Top cable entry with dual hook



Side cable entry with single button



Side cable entry with dual button

7. TYPICAL CONNECTOR WIRING

✓ Mold-power & Thermocouple Combination Type

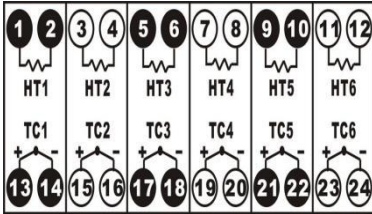

Wring mode1

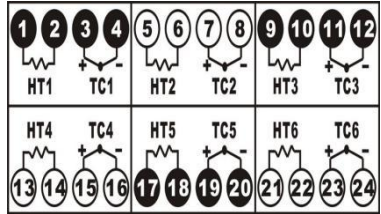

Wring mode 2

✓ Mold-power & Thermocouple Separated Type

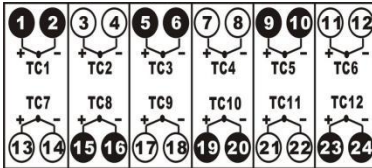
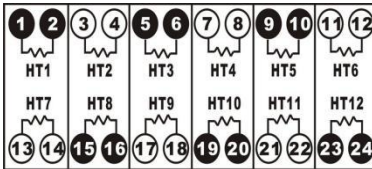

Wring mode3

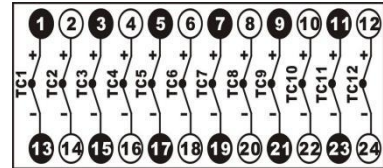
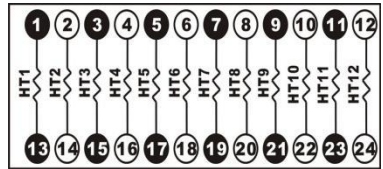

Wring mode 4

◆ TC- M01 Temperature Control Module

CAUTIONS

- Please read the instructions carefully before any operation.
- If there are any signs indicate that the temperature control module is damaged during transportation, please do not power on it.
- Before the temperature control module is powered on, please
 - 1) Confirm if the power supply of the mainframe meets the requirements;
 - 2) Confirm if the mold-power & thermocouple cable is connected reliable and the wiring mode on controller mainframe is same as on the mold.
 - 3) Ensure that the fan of mainframe is in working condition.
- The temperature control module is set to be automatic closed-loop control mode before shipping. The power output maybe open after the module is powered on.

So before power on the module, please consider all of the possible impact on the production process.
- The temperature control module will show the code of thermocouple type, please check it and adjust the related setting according to this manual if it does not match the system.
- If the temperature control module alarms during working, please check the alarm code and analyze the cause.
- Before you pull out or insert the temperature control module, please turn off the module's power and the circuit breaker on the mainframe.

1. Specifications

- ◆ Power requirements: AC85~250V, 50/60Hz
- ◆ Sensor type: J or K thermocouple
- ◆ Setting range: 0°C~450°C (32°F~842°F)
- ◆ Measurement accuracy: $\pm 2^{\circ}\text{C}$
- ◆ Cold-junction compensation accuracy: $\pm 1^{\circ}\text{C}$
- ◆ Control mode: Auto PID or Manual
- ◆ Control accuracy: $\pm 0.5^{\circ}\text{C}$
- ◆ Control output device: Triac
- ◆ Load capability: 15A, 50W~1650W(110V),
100W~3600W(240V)
- ◆ Operating temperature: 0°C~55°C (32°F~131°F)
- ◆ Operating humidity: 10~85%, non-condensing
- ◆ Storage temperature: -20°C~70°C (-4°F~158°F)

2. Wiring

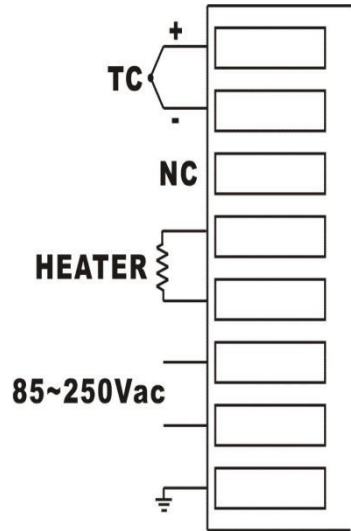

3. Faceplate

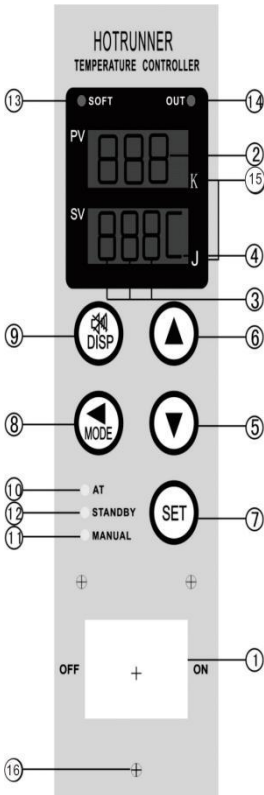

- ① **Power Switch:** Turn on or turn off.
- ② **PV:**
 - a) Normal mode: Present value.
 - b) Parameter mode: Parameter name.
 - c) Alarm mode: Error code about sensor.
- ③ **SV:**
 - a) Normal mode: Setting value/Power output(%) / Load current (A).
 - b) Parameter mode: Parameter value.
 - c) Alarm mode: Error code about triac or load.
- ④ **Temperature Unit:** Celsius (C) or Fahrenheit (F).
- ⑤ **Down Key:** Used for decrease setting number.
- ⑥ **Up Key:** Used for increase setting number.
- ⑦ **SET Key:** Used for parameter Calling up/Registration.
- ⑧ **Shift/Mode Key:**
 - a) Parameter mode: Used for select adjustable digit.
 - b) Normal mode: Used for switch control mode (Press it >1s):
Normal (Auto) \ Standby \ Manual \ AT (Auto Tune).
- ** When switch to AT mode, press SET key in 3s to start auto-tuning, or the controller auto-back to normal mode.**
- c) Soft start process: Press it to terminate soft start (when boS=1).
- d) BOOST function can be activated by pressing it after soft start process (when boS=1).
- ⑨ **Disp Key:**
 - a) Press it to switch SV/ power output % / load current display.
 - b) Press it to keep silence when the buzzer is beeping.
 - c) Press it >9s to change sensor type.
- ⑩ **Auto indicator:** Light up when controller is in AT mode.
- (11) **Manual indicator:** Light up when controller is in Manual mode.

(12) **Standby indicator:** Light up when controller is in Standby mode. (13) **Soft indicator:** Light

up when controller is in soft start mode.

(14) **Out indicator:** Light up when controller is not in soft start mode

(15) **Sensor type indicator:** K- Thermocouple K, J- Thermocouple J.

(16) **Mounting hole** .

4. Operating modes

■ Normal mode:

After power on self test, controller starts to work in normal mode.

PV displays present temperature value, and SV displays setting temperature value (Auto control) or power output percent (Manual control).

Note: Auto/Manual control mode, and the output percent of Manual control when power on, see parameter “nSL”.

In this mode, you can

- 1) Change setting temperature value (Auto control) or setting power output percent (Manual control): Press \wedge 、 \vee 、 \lt to modify the setting, and the modified value will become effective after 3sec., or press **SET** to make it effective at once.
- 2) Change setting temperature value (Auto control): Press **SET** to enter the setting temperature value adjustable state (flashing), then press \wedge 、 \vee 、 \lt to change it and press **SET** to save it.
- 3) Enter the parameter mode: Press **SET** >1sec.
- 4) Switch control mode (Auto-Standby-Manual-AT): Press **MODE** >1sec.
**** When shift to AT mode, press SET key in 3SEC. to start auto-tuning, or the controller auto-back to normal mode.**
- 5) Switch setting value / load current (Amps) / power output (%) display: Press **DISP**.
- 6) End soft start process: Press **MODE** (when boS=1).
- 7) Activate BOOST function: Press **MODE** (when boS=1, and soft start process end).
- 8) Change sensor type: Press **DISP**>9sec.

■ Parameter mode:

By pressing **SET** >1sec. in normal mode, the controller enters the parameter mode.

It displays parameter name and its value. In this mode, you can

- 1) Change the parameter value: Press \wedge 、 \vee 、 \lt to modify the value, and press **SET** to save it, then the next parameter and its value are displayed.
- 2) Look over the parameters: Press **SET** to shift the parameters.
- 3) Exit the parameter mode with saving: Press **SET** >1sec.

If there's any operation in 60sec., the controller will exit the parameter mode without saving automatically.

■ **Alarm mode:**

The controller displays the corresponding faulty code.

5. Control modes

■ **Normal (Auto PID) mode:**

This type of control is a “closed-loop” system and requires a thermocouple feedback signal.

The controller displays present temperature value and setting temperature value.

The controller uses a PID algorithm to determine the required output power to hold the present temperature value equal to setting temperature value.

■ **Standby mode:**

This type of control is similar to auto mode. It is a “closed-loop” system and requires a thermocouple feedback signal.

The controller displays present temperature value and standby temperature value (70% of setting temperature value).

The controller uses a PID algorithm to determine the required output power to hold the present temperature value equal to standby temperature value.

Standby mode can be activated or stopped by an external signal (when Std \neq 0).

■ **Manual mode:**

This type of control is an “open-loop” system and requires no thermocouple feedback signal.

It can be used when thermocouple is failed or without thermocouple in system.

The controller displays present temperature value and power output percent setting.

Note: The output percent initial value, see parameter “A-n” and “nSL”.

The controller regulates output power according to the setting. The setting can be adjusted by pressing \wedge 、 \vee 、 \lt keys.

■ **AT (PID Auto Tune) function:**

This function is for getting the optimal PID value in some system.

It is a “closed-loop” system and requires a thermocouple feedback signal.

Generally, AT function is only been executed when PID factory setting cannot meet the system requirements.

After finished auto tuning, the optimal PID value would be saved, and the controller returns to normal (auto PID) mode.

When $\text{SuP} \leq 900$, the controller executes auto-tune function by making 80% of setting value as target.

When $\text{SuP} > 900$, the controller executes auto-tune function by making setting value as target.

6. Soft start (dehumidify) function

To avoid the humidity make the heater burn out, the soft start function could heat slowly to make dehumidify action when turn on the power.

During soft start time, the output power step up slowly from 0% to make the temperature rise to 100°C (212°F) slowly and hold it.

When soft start time is over, the controller will return to normal (auto) control mode.

Soft start condition:

- a) The controller is set for Normal (Auto) Control mode.
- b) The soft start function is on (parameter $\text{Sot}=1\sim 10$).
- c) The process temperature is less than 100°C (212°F).

7. Boost (speed up heating) function (when $\text{boS}=1$)

In normal (auto PID) control mode (soft start process is over), press **MODE** key to activate the boost function.

For the next 15 seconds (or until you press the **MODE** key again, which ever is sooner), 20% is added to the controller output (100% output or parameter Pub limited maximum).

8. Parameters

8-1. General parameters

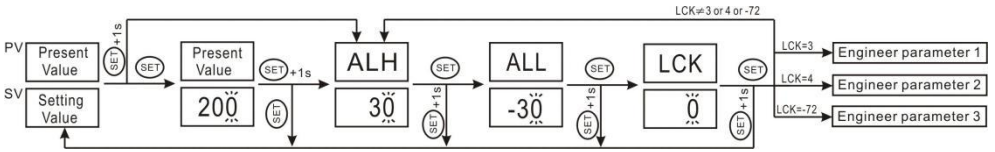

1) **Setting Value:** full scale.

Notes : It can be set by pressing \wedge 、 \vee 、 $<$ directly and the modified value will become effective after 5sec., or press **SET** to make it effective at once.

2) **ALH:** high deviation alarm value.

When present value $>$ SV+ALH, the buzzer is beeping, and the output is shut off (when $Adr < 100$).

No alarm when power on or after modifying the setting until new alarm happens.

3) **ALL:** low deviation alarm value.

When present value $<$ SV+ALL, the buzzer is beeping.

No alarm when power on or after modifying the setting until new alarm happens.

4) **LCK:** parameter setting lock.

0: Off; 1: On, all parameters cannot be changed; 11: On, all parameters

cannot be changed except setting value.

8-2. Engineer parameters 1

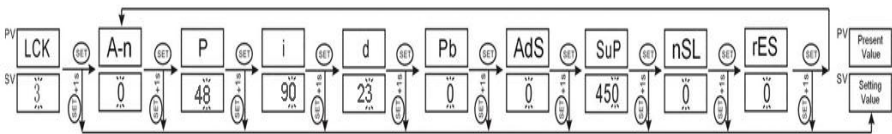

1) **A-n:** initial power output percent for manual control, 0~100%, used with parameter nSL.

Note: When A-n is effective, its value is auto-refreshed by latest manual output percent.

2) **P:** control proportion band, 1~999.

- 3) **i**: integral time, 0~999s.
- 4) **d**: differential time, 0~999s.
- 5) **Pb**: PV bias, -120~120. Sensor correction is made by adding Pb to measured value (PV).
- 6) **AdS**: ambient temperature (internal mainframe) high alarm value, temperature unit is same as parameter C-F setting.
When AdS=0, this function is off.
- 7) **SuP**: SV setting upper limit / AT target setting (see AT function), full scale.

When SuP = 453 and the starting temperature is below 90% of the target value, the adaptive function is turned on, otherwise the default parameter control in the card is used (ps: adaptive function is suitable for stable production).
- 8) **nSL**: Manual/Auto control mode.
 - 0: Auto mode when power on; initial power output is same as auto mode when shift to manual mode.
 - 1: Auto mode when power on; initial power output is same as parameter A-n when shift to manual mode.
 - 2: Manual mode when power on; initial power output is 0%.
 - 3: Manual mode when power on; initial power output is same as parameter A-n.
 - 4: If auto mode when power off, same as nSL=1 when power on;
If manual mode when power off, same as nSL=3 when power on.
- 9) **rES**: initialize controller.
 - 0: Off.
 - 1: All parameters are reset to factory setting after power-on.

8-3. Engineer parameters 2

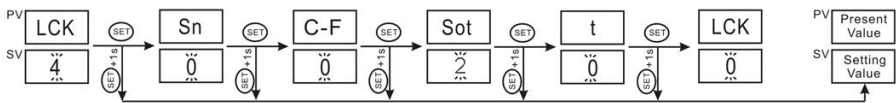

- 1) **Sn**: sensor Type (can be changed quickly by pressing **DISP** >9s in normal operating mode).
 - 0: J type thermocouple; 1: K type thermocouple.
- 2) **C-F**: temperature unit.
 - 0: °C; 1: °F.
- 3) **Sot**: soft start (heater dehumidify) function.

0: Off; 1~10: On, soft start time= $Sot \times 80s$

Notes: The rest of soft start time reduced to one-third if the process temperature reached $100^{\circ}C$ ($212^{\circ}F$).

4) t: output control type.

0: phase control output;

1~10: zero-switching control output, proportional cycle = $t \times 1s$

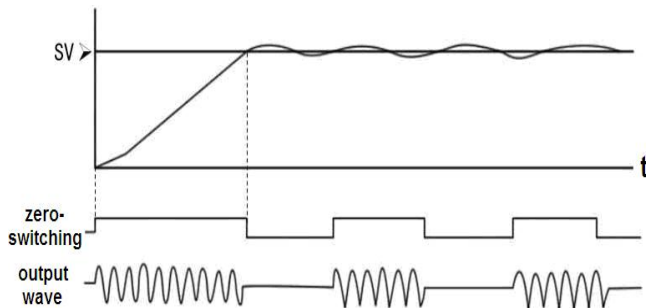
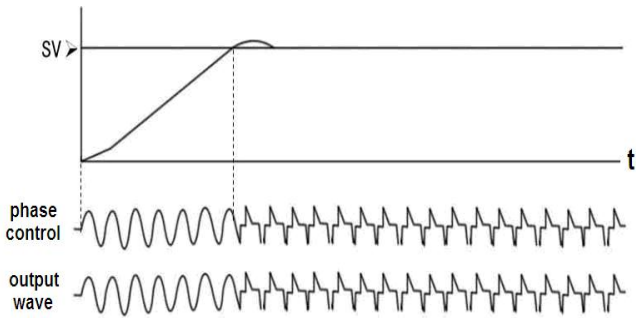

9. Default of parameters

Parameter	Default	Parameter	Default	Parameter	Default
SV	200	i	90	Snb	1
ALH	30	d	23	HEA	4
ALL	-30	Pb	0	inA	18
LCK	0	Ads	0	Pi	50
Sn	0	Sup	450	SHT	0
C-F	0	nSL	0	boS	0
Sot	2	rES	0	EHo	0
t	0	Pub	0	Vol	9
A-n	0	AiN	15		
P	48	Adr	0		

10. Alarm messages

Alarm Code	Troubles	Solution
S E r	Misconnection of thermocouple & heater	Check the wiring, make $S_{nb}=0$ if the connection is right.
E r H	Thermocouple open	Check the sensor, or switch to manual control mode.
E r L	Thermocouple inverse	
H E A	Heater fault	Check the heater.
t r S	Triac error	Replace the triac.
A L H	High deviation alarm	Check the controller & the sensor.
A L L	Low deviation alarm	Check the system thermal insulation, or switch to manual control mode.
Current in SV flash	Over load	Check the load.
S H t	Short load	Check the load.
H E r	Thermocouple is out of its position	Check the thermocouple.
H o t	Ambient temperature is too high	Check the fans of mainframe.
H H H	Over voltage	Check the power supply.